

Suspension de ligne de contact TB avec corps isolé type 2, en courbes sur tube G2.5" 10.5-14° avec griffe de courbe type 3, M16

Référence 103395

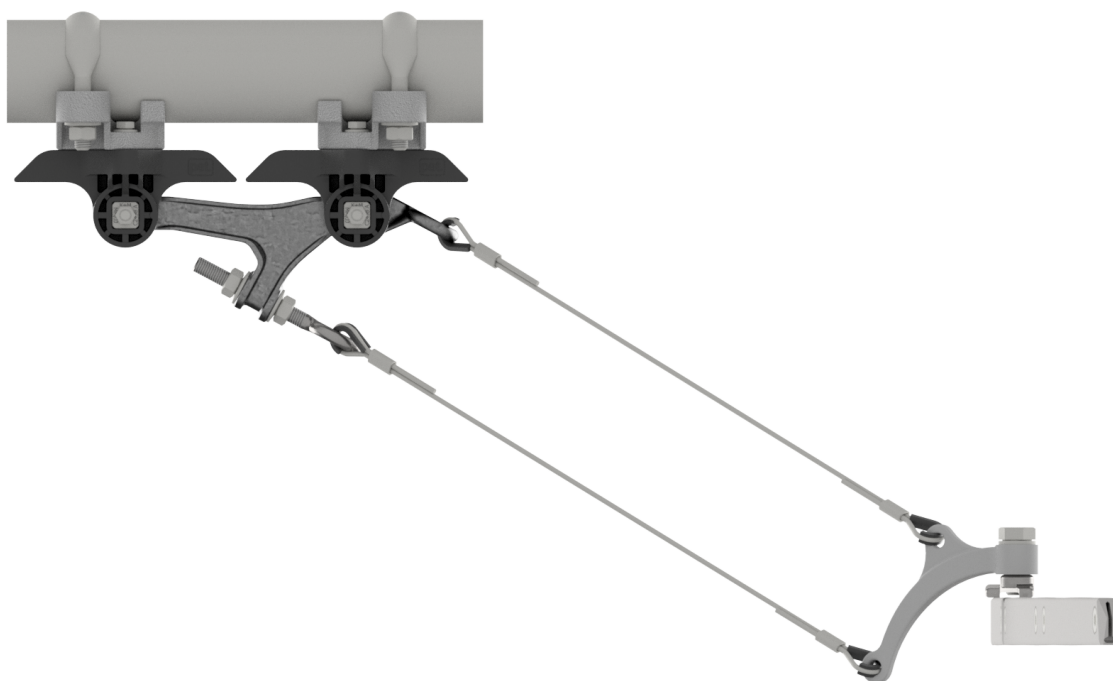

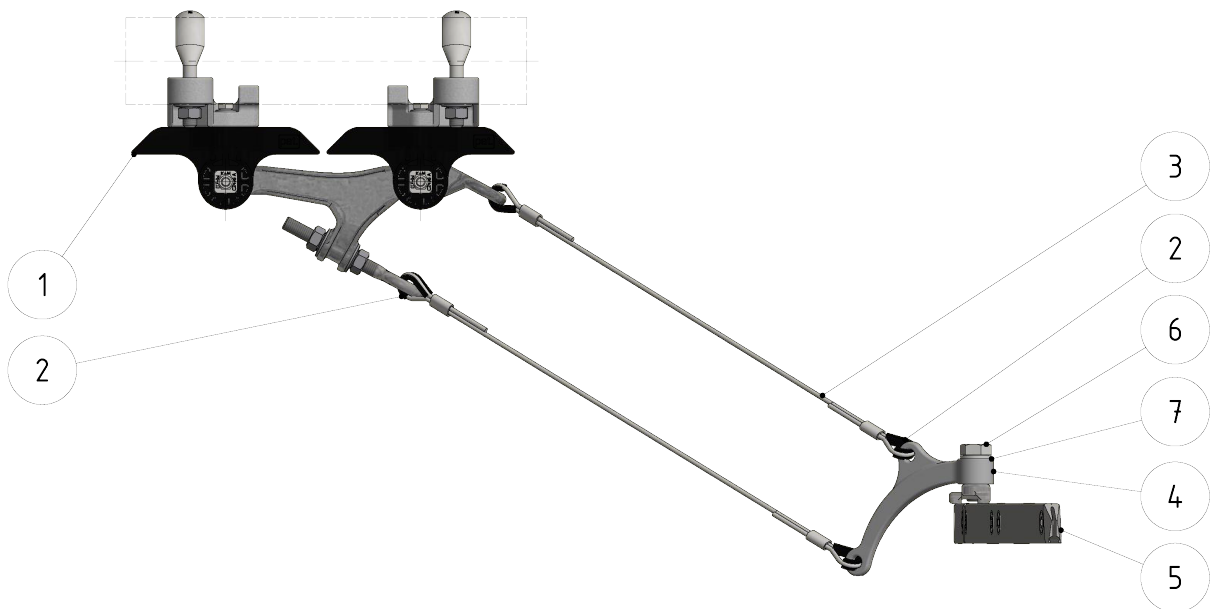

Spécifications

Tension de service: max. 1500 V C.C.

Remarques

- Corps isolé plast./acier inox/Al

- Accessoires acier inox
- Griffes de courbe M16 acier galv.

remplace

101816