

C1049-01

CROSSING PIECE ETB-ETB, RIGID, 25°

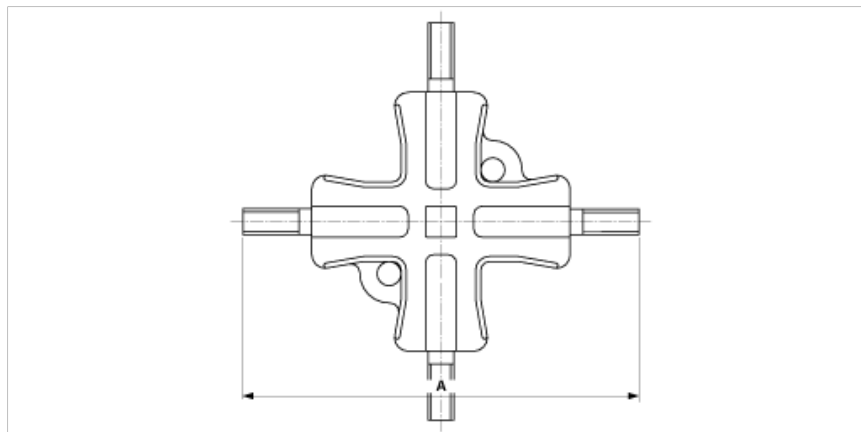

DIMENSIONS

A: 380 mm

MATERIAL AND WEIGHT

Material: Bz

Weight: 4.050 kg

COMMENTS

- For tube connection