

C1051-01

CROSSING PIECE ETB-ETB, RIGID, 35°

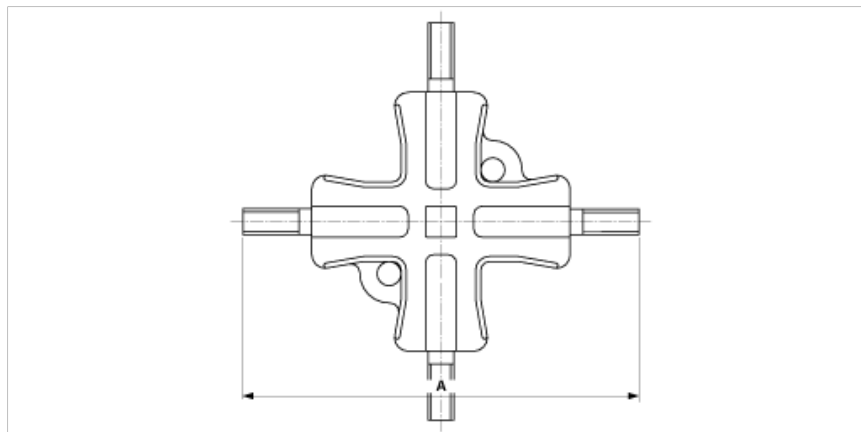

DIMENSIONS

A: 320 mm

MATERIAL AND WEIGHT

Weight: 3.700 kg

Material: Bz

COMMENTS

- For tube connection