

**C1053-01**

**CROSSING PIECE ETB-ETB, RIGID, 45°**

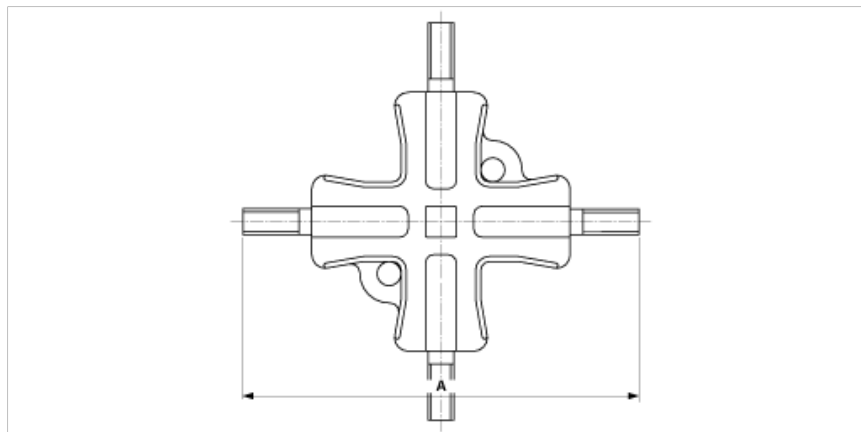

**DIMENSIONS**

A: 275 mm

**MATERIAL AND WEIGHT**

Material: Bz

Weight: 2.850 kg

**COMMENTS**

- For tube connection