

C1054-01

CROSSING PIECE ETB-ETB, RIGID, 50°

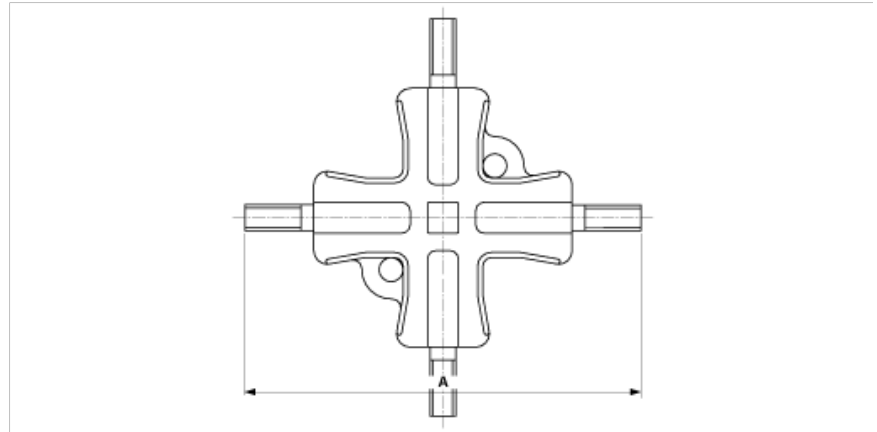

DIMENSIONS

A: 260 mm

MATERIAL AND WEIGHT

Material: Bz

Weight: 2.700 kg

COMMENTS

- For tube connection