

C1055-01

CROSSING PIECE ETB-ETB, RIGID, 55°

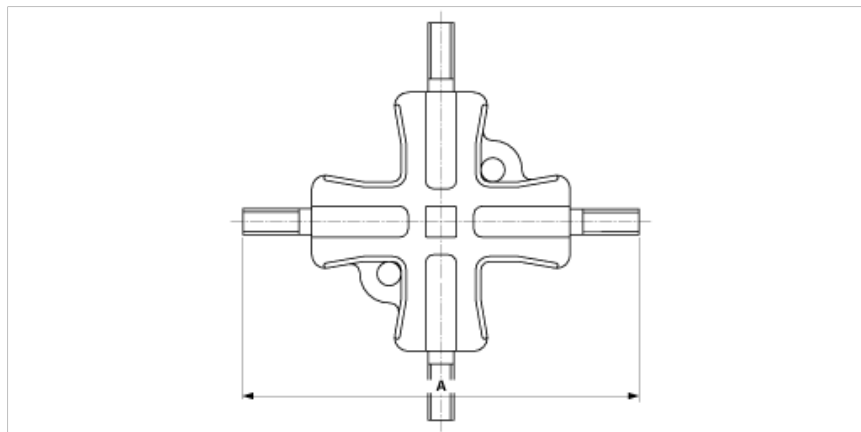

DIMENSIONS

A: 245 mm

MATERIAL AND WEIGHT

Material: Bz

Weight: 2.560 kg

COMMENTS

- For tube connection