

C1056-01

CROSSING PIECE ETB-ETB, RIGID, 60°

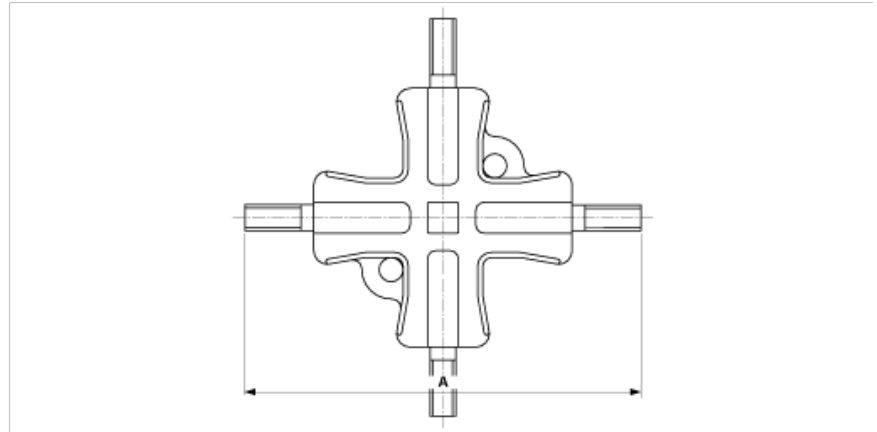

DIMENSIONS

A: 230 mm

MATERIAL AND WEIGHT

Material: Bz

Weight: 2.260 kg

COMMENTS

- For tube connection