

**C1059-01**

**CROSSING PIECE ETB-ETB, RIGID, 75°**

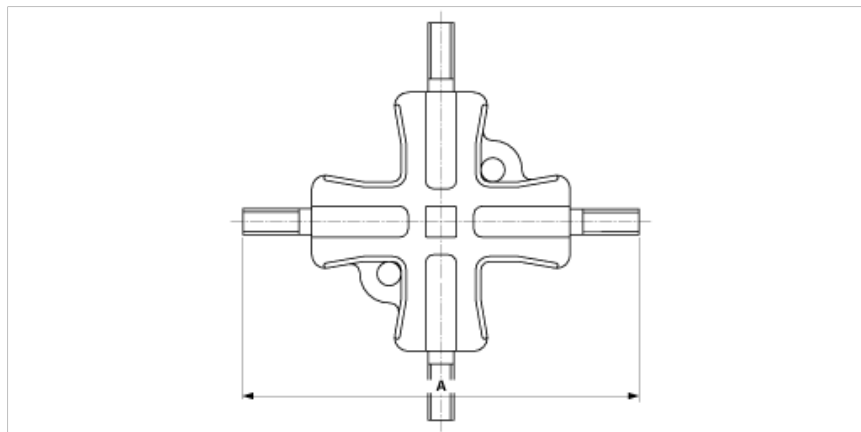

**DIMENSIONS**

A: 230 mm

**MATERIAL AND WEIGHT**

Material: Bz

Weight: 2.300 kg

**COMMENTS**

- For tube connection