

C1061-01

CROSSING PIECE ETB-ETB, RIGID, 85°

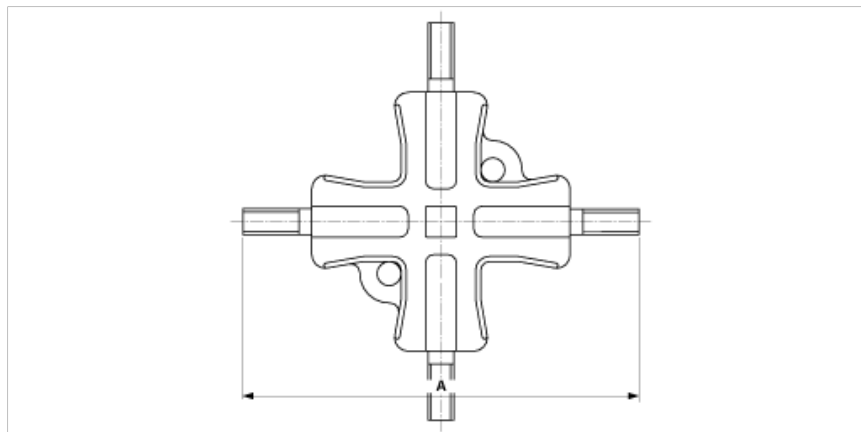

DIMENSIONS

A: 230 mm

MATERIAL AND WEIGHT

Weight: 2.460 kg

Material: Bz

COMMENTS

- For tube connection