

C1062-01

CROSSING PIECE ETB-ETB, RIGID, 90°

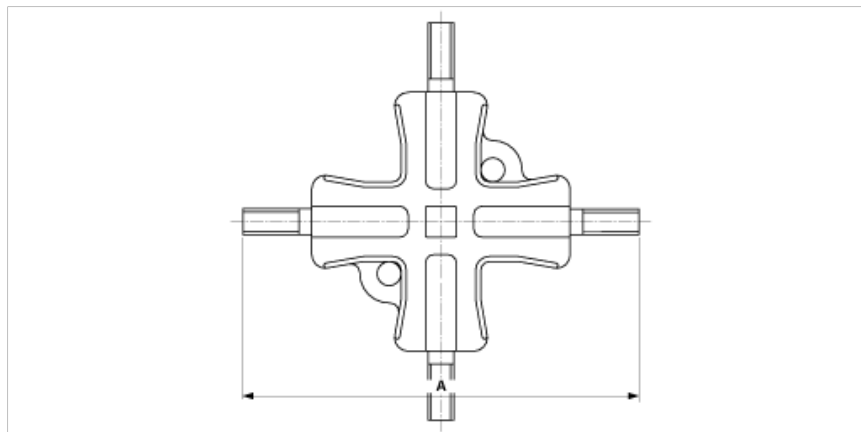

DIMENSIONS

A: 230 mm

MATERIAL AND WEIGHT

Material: Bz

Weight: 2.520 kg

COMMENTS

- For tube connection