

E3314-04

PIPE $\varnothing = 38$ MM FOR DROP BRACKET CLAMP MOVABLE $\pm 15^\circ$, L = 220 MM

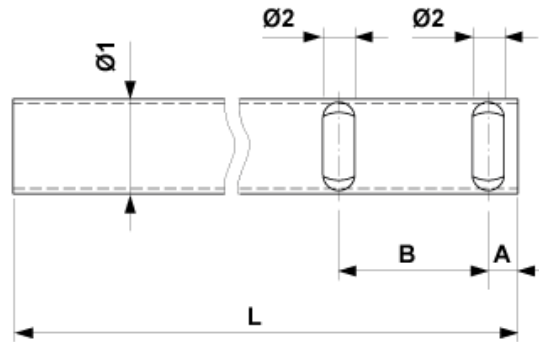

DIMENSIONS

B: 60 mm

A: 12 mm

$\varnothing 1$: 38 mm

L: 220 mm

$\varnothing 2$: 12.8 mm

MATERIAL AND WEIGHT

Weight: 0.500 kg

Material: SST

COMMENTS

- Other lengths on request